

***Nowei***

**Foshan Nuowei Digital Printing Equipment Co., Ltd.**

**型号: NV-DTF-60**

# INTELLIGENT DIRECT TO FILM PRINTER

All-in-one printer / Intelligent and efficient

NV-DTF-60Plus

a good printer always let you have sweet dream



Support 600mmx10000mm (wxh), To Reach Super Image Printing

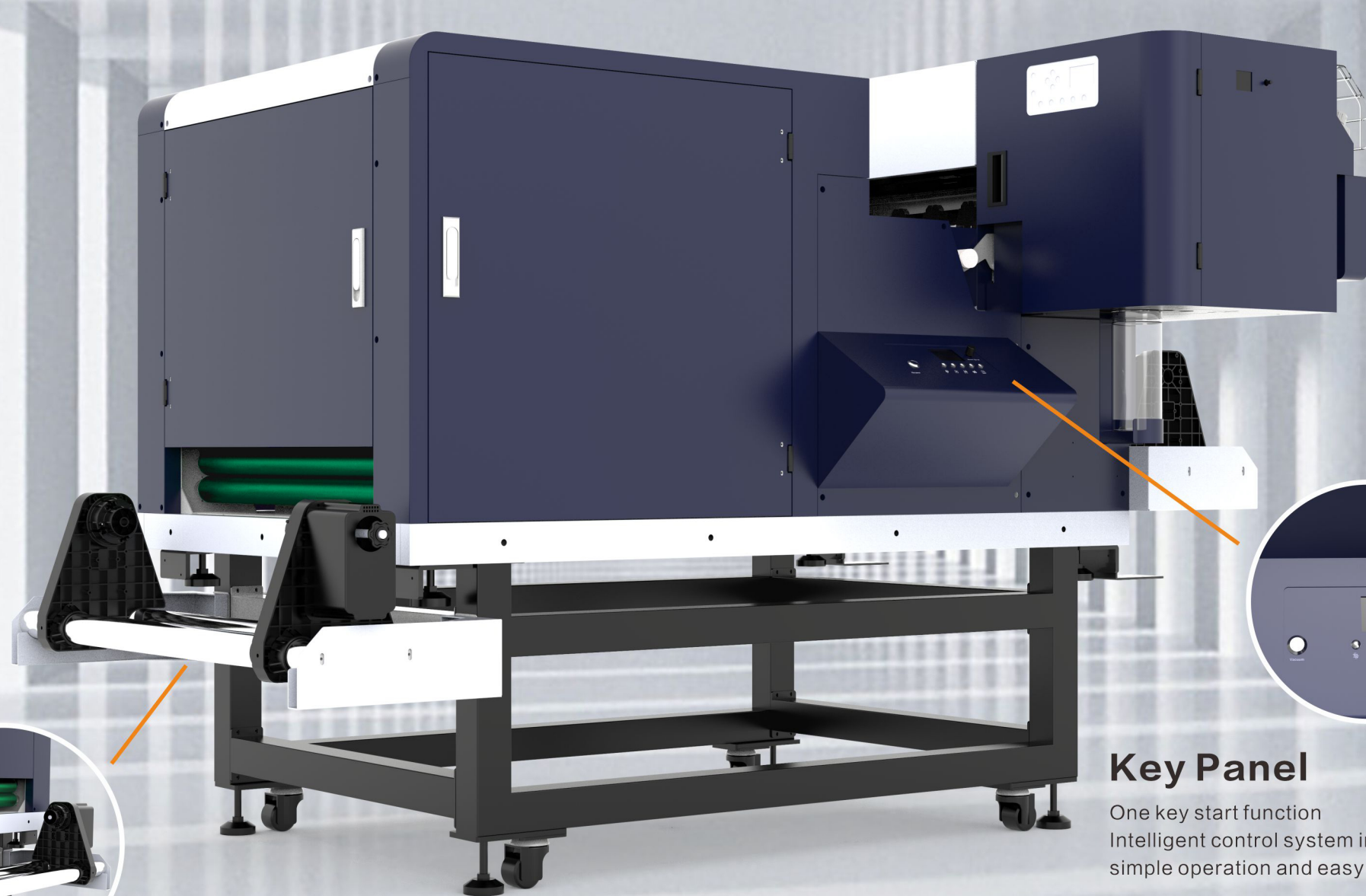

**Automatic roller device**  
Film receiver automatically

**Key Panel**

One key start function  
Intelligent control system in English and Chinese,  
simple operation and easy to understand

## PRODUCT DETAILS

Let You Know Me Better

White ink recirculation automatically

White and color can print at the same time

Suitable for all kinds of fabric material

High quality image

Good performance and stable machine

1

### Automatic ink supply system

With ink stirring, filtering, ink alarm function to ensure smooth ink supply;  
With transparent box to check the ink volume at any time.

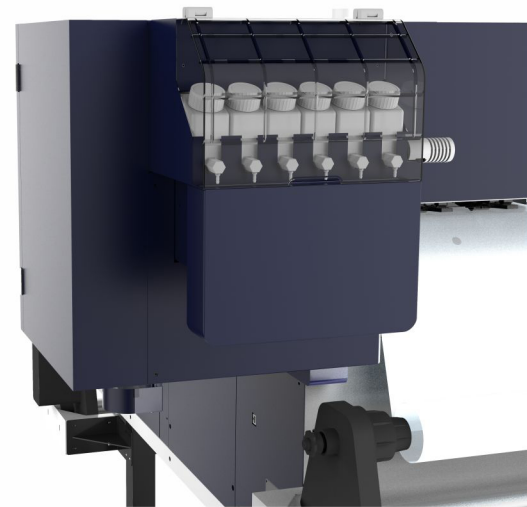

2

### Automatic adsorption, rotating device

Flat transfer and easy to operate with rotary device

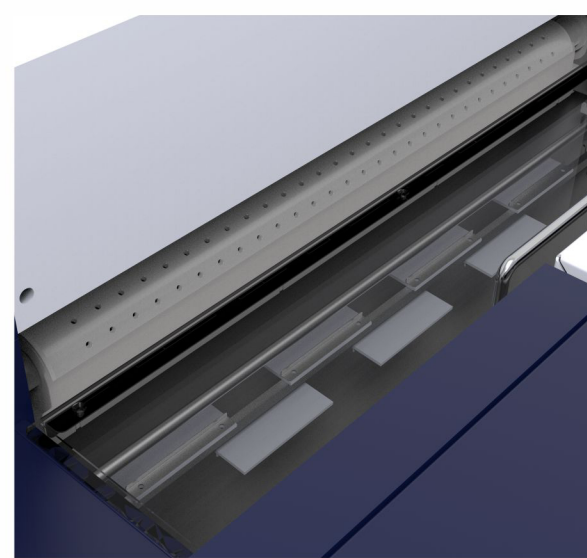

3

### Fully automatic circulating powder feeding system

Add the powder according to the actual needs to make sure it can be fully used



4

### Epson i3200 print head

Supporting 2400 dpi  
White and colors can be print at the same time  
Clear pictures and brilliant colors



5

### Special smoke filter

Electrolytic filtration with cleaner effect  
Large wind power, low noise, strong smoke removal force



6

### Platform heatin

Printing and heating at the same time for more efficient production



Only need four steps for the whole progress

Can be used for all different kinds fabric materials. Easy to operate

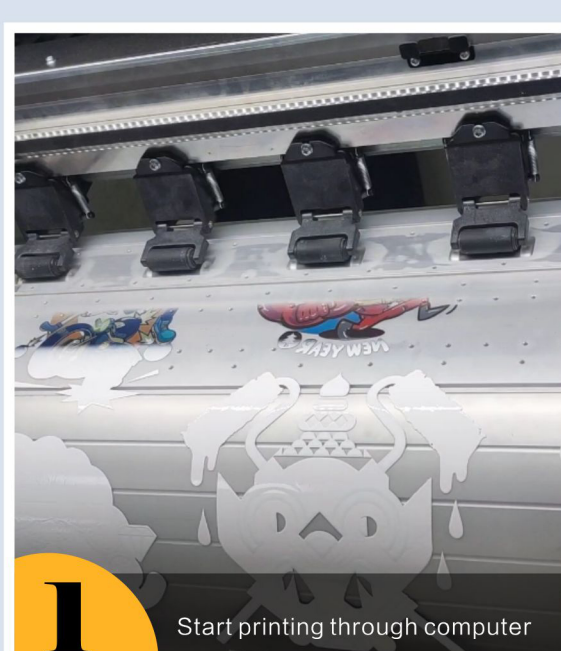

## PARAMETERS

Model number :	NV-DTF-60
Print head :	Epson i3200
Head qty:	2
Max printing scale:	600mmx10000mm
Thickness of printing :	0-3mm
Resolution:	2400dpi
Print mode :	White and color
Print method:	CMYK+W
Print software:	Future Rip
File format:	Tiff / Jpg / Eps / Pdf / Png / Ai / Psd
Power requirements:	AC220/ ± 10,50HZ~60HZ
Working enviroment:	Temperature 25°C -30°C Humidity:35%-60%
Ink type :	pigment ink
Dimensions:	2005mm*1595mm*895mm ( L*W*H )
Printer weight:	302kg ( Chassis 33kg )

**型号: NV-DTF-30**

# NV-DTF-30

## Small size DTF printer

Supporting 370mm width printing

- White and color can print at the same time
- High stability
- Automatic alarm
- Vivid image

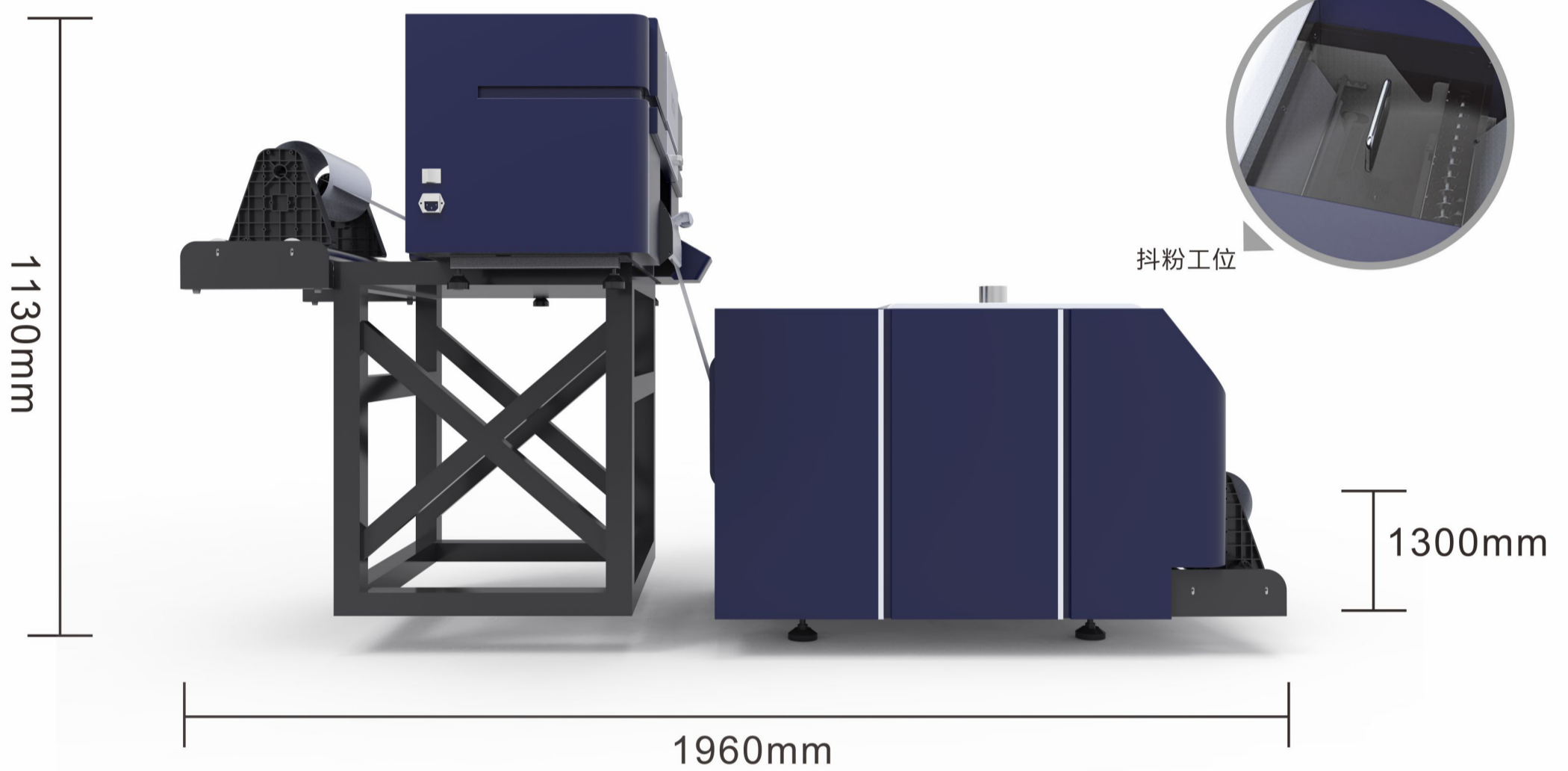

External ink supply cartridges

Transparent ink cartridge for easy refilling and to check the ink balance at any time

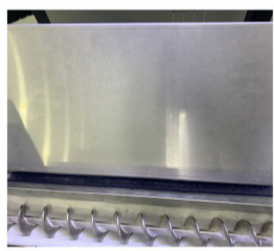

Heating panel

Heating and printing at the same time, more evenly baked



Epson i1600 print head

high definition printing



Fully automatic circulating powder feeding system

Add the powder according to the actual needs to make sure it can be fully used

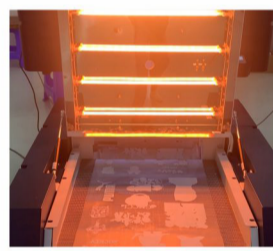

Heated tunnel

Tunnel baking, more uniform heating

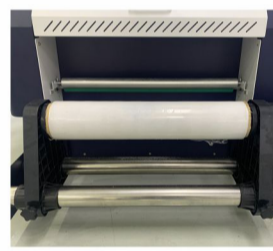

Automatic rewinding device

Roller receiver automatically



Operating panel

Intelligent operating system, easy to understand

## PARAMETERS

Model number : NV-DTF-30

Print head : EPSON I 1600

Head qty: 2

Max printing scale: 370mm\*10000mm

Thickness of printing : 0-3mm

Print accuracy: 2400dpi

Print mode: White and color

Print method: CMYK +W

Print RIP : Photoprint

File format: Tiff / Jpg / Eps / Pdf / Png / Ai / Psd

Power requirements: AC220/110 ± 10, 50HZ~60HZ

Working environment: Temperature :18-35°C Humidity:35-85%

Type of ink: Water-base

Dimension: 1960mm\*1300mm\*1130mm (长\*宽\*高)

Weight: 150kg

型号: NV-DTG-Pro

# Direct to garment printer

Plate free printing, one click printing, say goodbye to the tedious

**NV-DTG-Pro T-shirt printer**

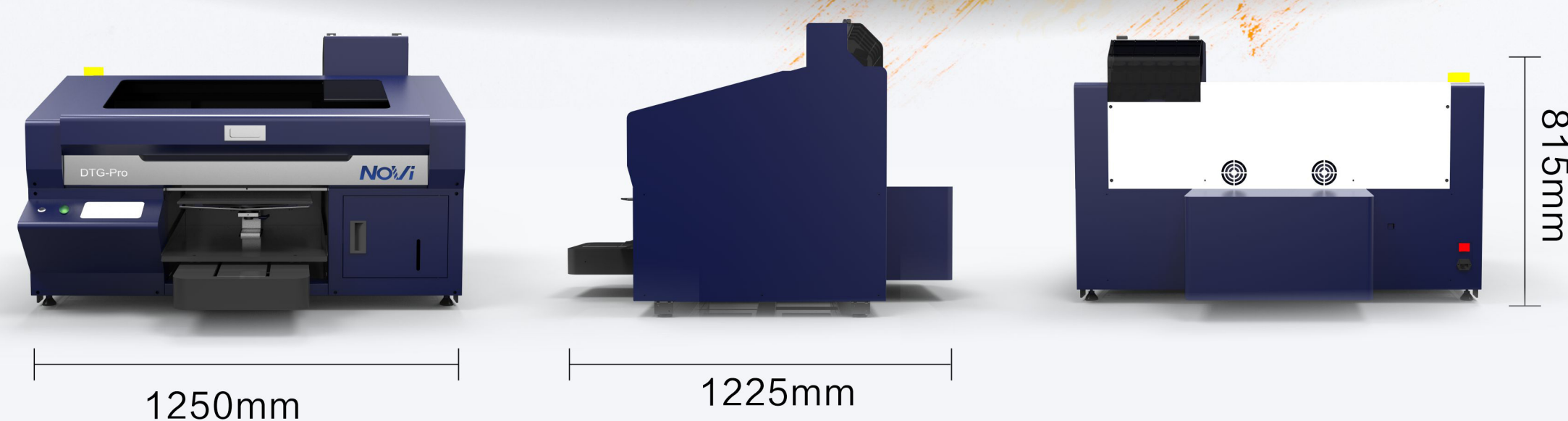

## Anatomy of a detail made by craftsmanship

DETAIL ANATOMY

Vivid colors | Wash resistant | Solid color | Eco-friendly ink

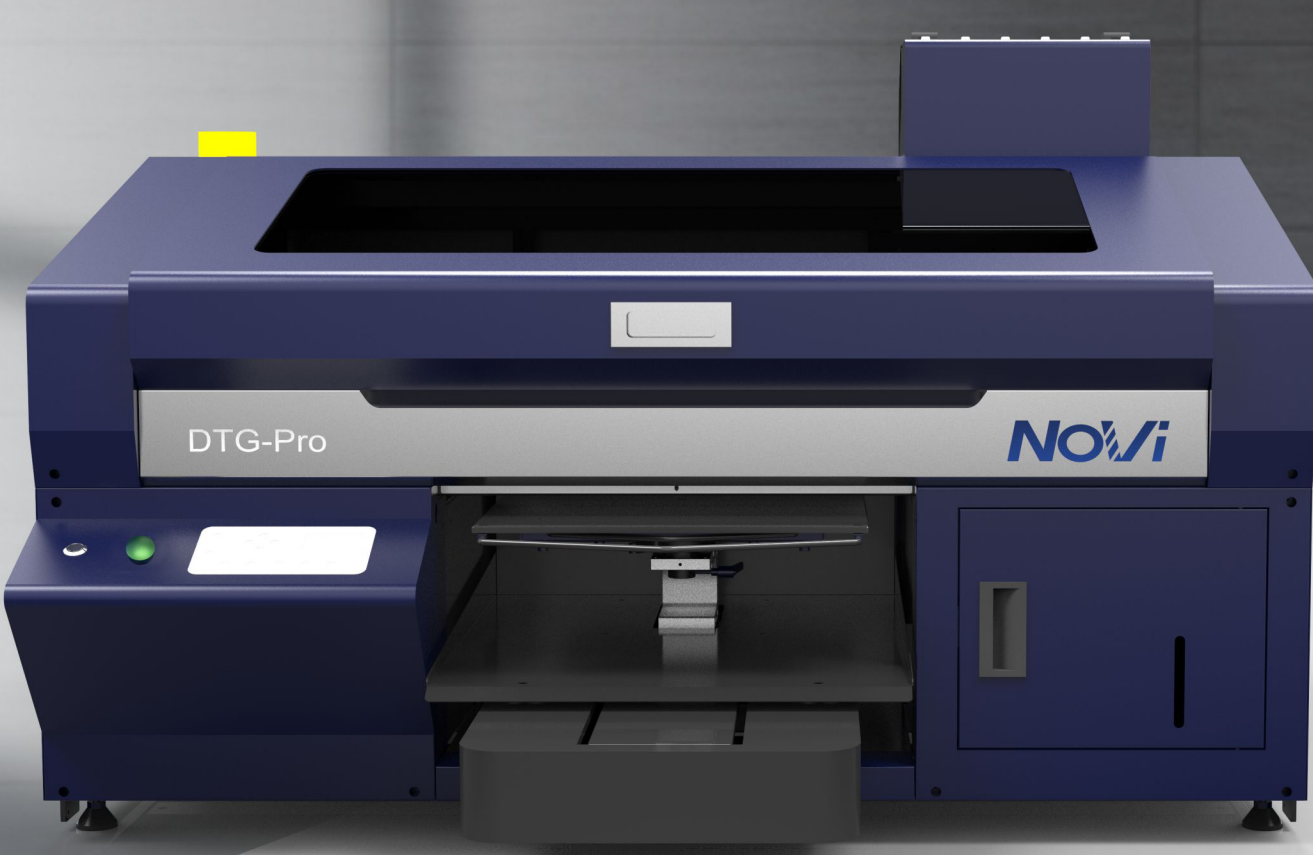
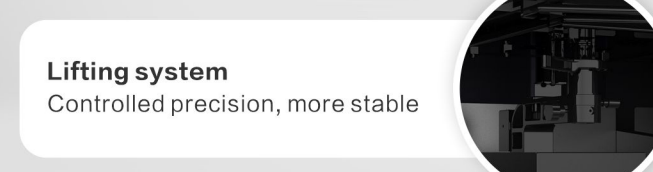
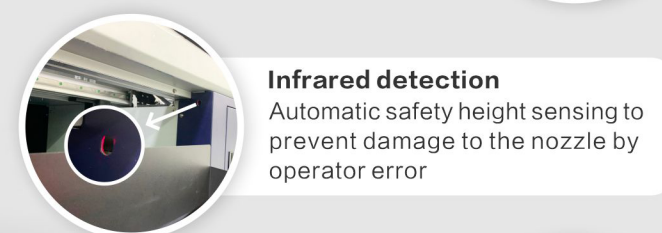
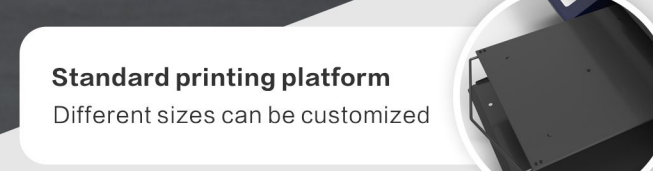
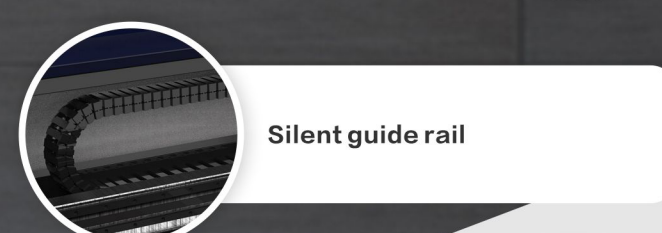
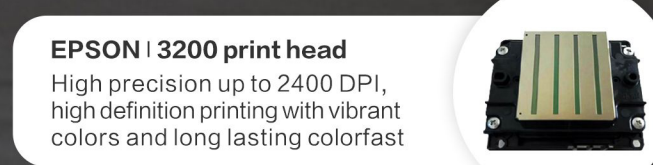
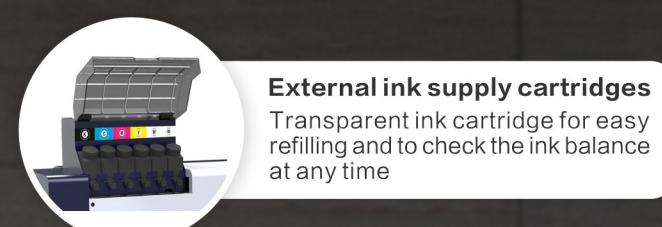

## PARAMETERS

Model number :	NV-DTG-Pro
Print head :	EPSON I 3200
Head qty:	2
Max printing scale:	406mm*457mm、371mm*421mm、356mm*406mm、254mm*305mm、178mm*203mm
Thickness of printing :	0-30mm
Print accuracy:	720X1800dpi ( 6pass)
Print speed :	1min/picture
Print mode:	White and color
Print direction:	Single and double
Print RIP :	PowerPlotter7
Working environment:	Temperature :10-30℃ Humidity:35-65%(No condensation)
Printing environment:	Temperature :18-30℃ Humidity:45-65%(No condensation)
Resolution:	No less than XGA (1024x768)
Type of ink:	Water-base
Dimension:	1250mm*1225mm*815mm ( L*W*H )
Weight :	145kg

型号: NV-DTG-Pro II



# Dual Tray Dtg Printer

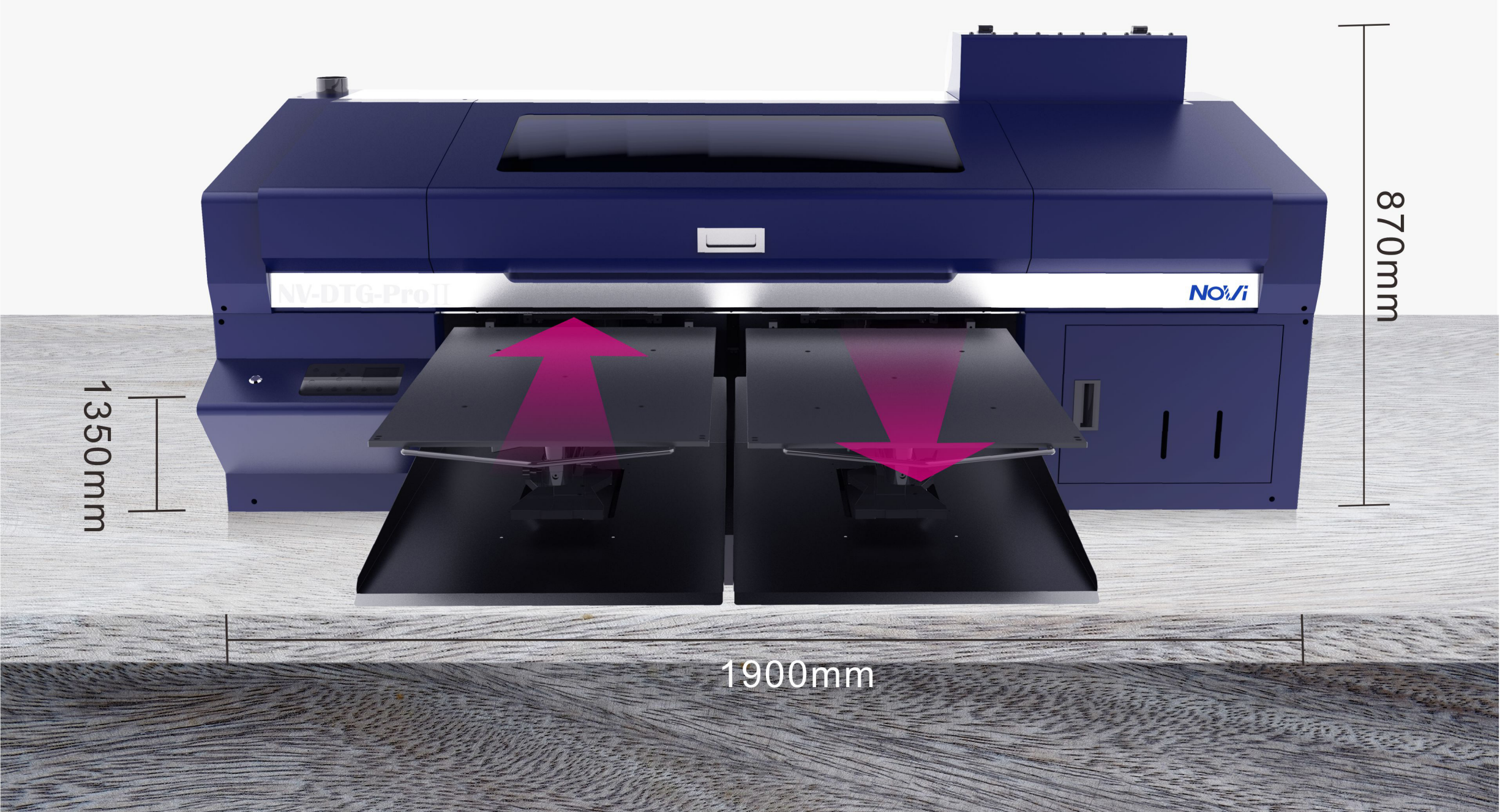

## Anatomy of a detail made by craftsmanship

### DETAIL ANATOMY



Vivid colors | Wash resistant | Solid color | Eco-friendly ink



## PARAMETERS

Model number :	NV-DTG-Pro II
Print head :	EPSON I 3200
Head qty:	3
Max printing scale:	450mm*600mm、406mm*457mm、371mm*421mm 356mm*406mm、254mm*305mm、178mm*203mm
Thickness of printing :	0-30mm
Print accuracy:	720X1200dpi ( 4pass)
Print speed :	1 min/picture
Print mode:	White and color
Print direction:	Single and double
Print RIP :	PowerPlotter7
Working environment:	Temperature :10-30℃ Humidity:35-65%(No condensation)
Printing environment:	Temperature :18-30℃ Humidity:45-65%(No condensation)
Resolution:	No less than XGA (1024x768)
Type of ink:	Water-base
Dimension:	1900mm*1350mm*870mm ( L*W*H )
Weight :	252kg

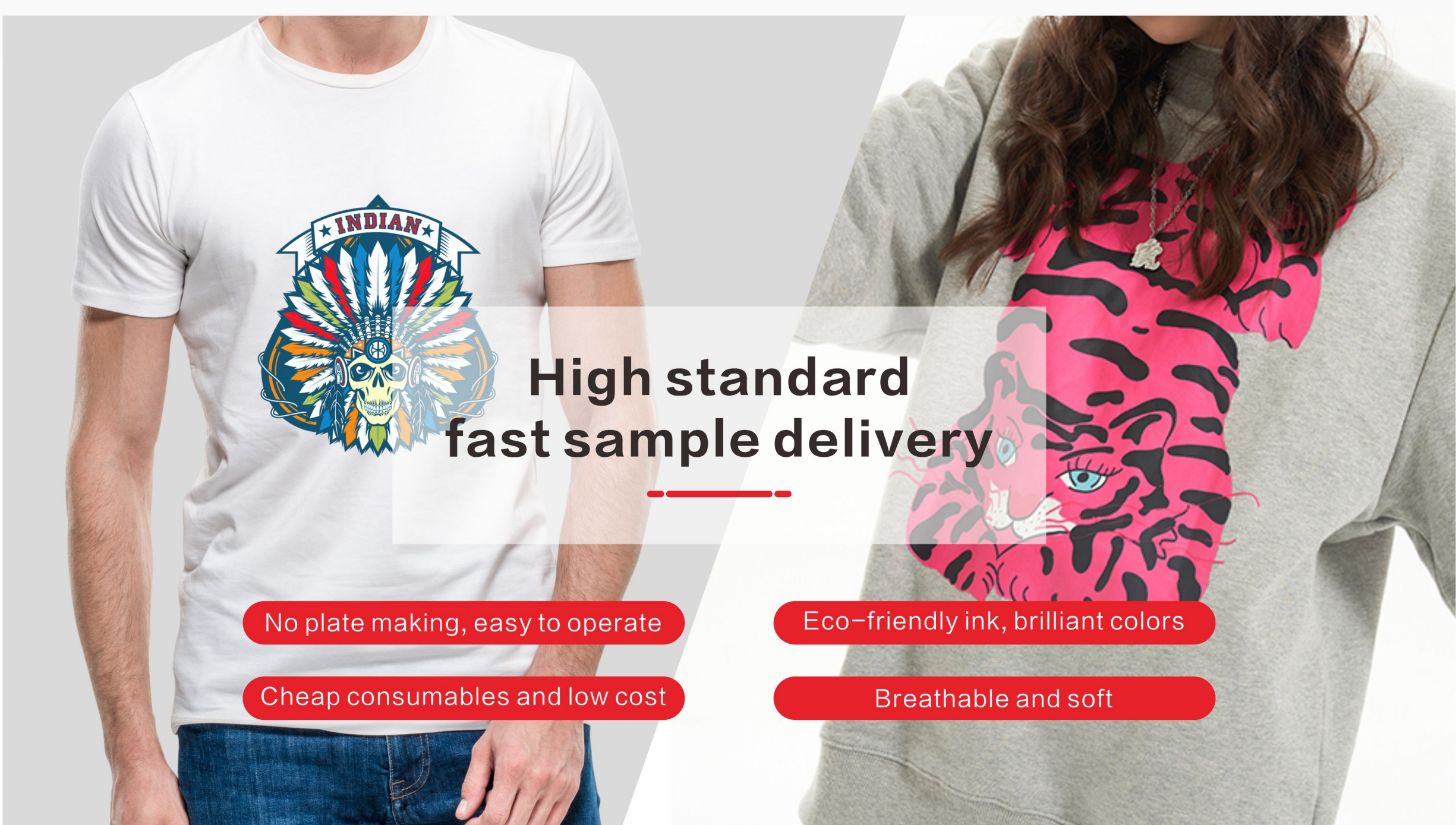

型号: One Pass

One Pass High Speed T-shirt Printer  
**24 printheads splicing technology**

High speed printing, can print white T-shirt 300 pcs/hour, and black T-shirt 150pcs/hour.

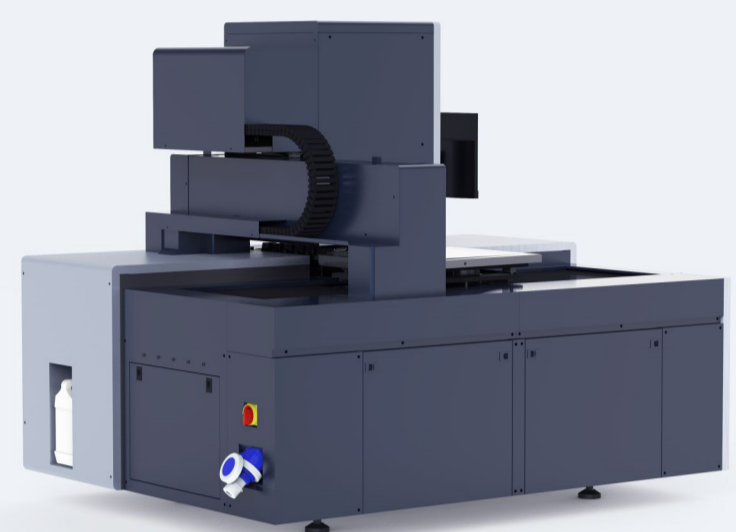
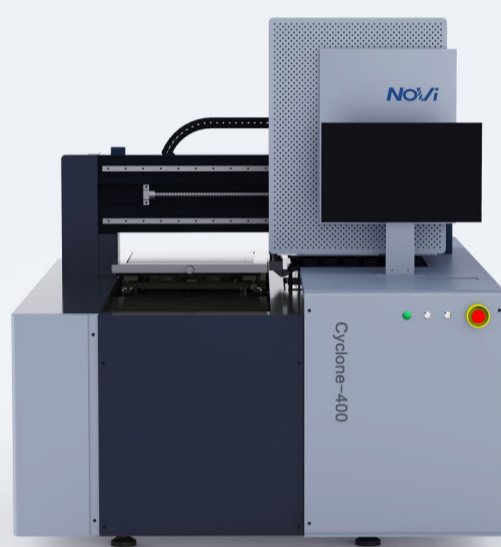
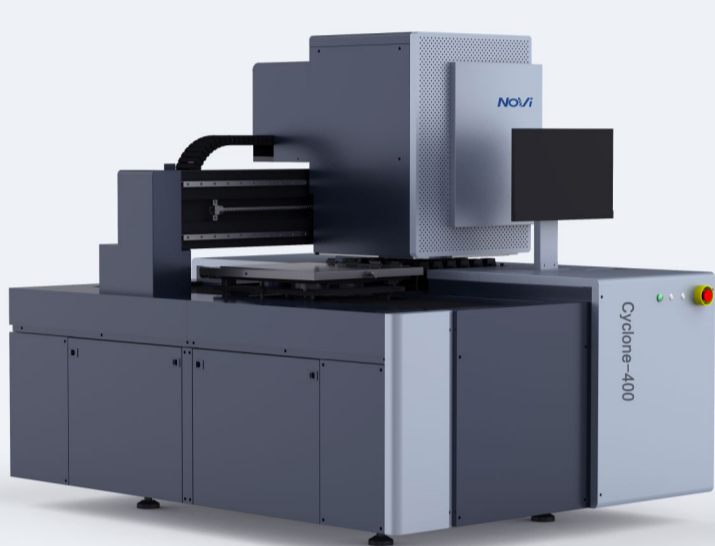

## CORE ADVANTAGES



Intelligent



High-speed



Easy to operate



Multi-functional

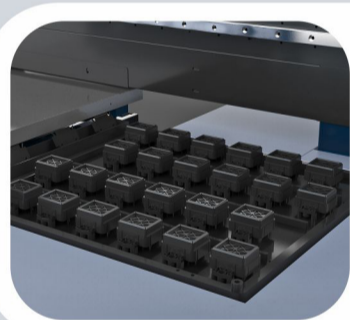

### Lifting ink station design

Use motor for driving ; precise positioning;  
Better protection for print head



### Negative pressure ink supply

Unique design with 3rd cartridge negative  
pressure ink supply system. To make sure  
ink supply smoothly



### Intelligent print head protective system

Distinguish from traditional inking technology,  
which can inking and cleaning for individual  
printheads. Saving the ink volume



### Epson i3200-A1 print head

High accuracy, high efficiency;  
Vivid and delicate colors



### Natural marble structure

The beam, base and body are all marble  
construction for more stable printing



### Imported high-precision screw rail

Y-axis with ball screw drive for smooth  
running and accurate printing

## PARAMETERS

Model:  
NV-Cyclone-400

Qty of print head:  
24

Model of head :  
EPSON I3200-A1

Max resolution:  
2400dpi ( 8pass )

Print mode :  
CMYK+W

Print thickness:  
0-50mm

Print width:  
400mm\*460mm

Dimension:  
2630mm\*1630mm\*1710mm

Net weight:  
1700KG

Voltage:  
AC220V± 10, 50HZ-60HZ

Working temperature:  
Temperature 20°C-28°C  
Humidity 35%-65%

Graphic format:  
Tiff / Jpg / Eps / Pdf / Png / Ai / Psd

**型号: NV-UV6060**

# High-end UV flatbed printer

Lifting platform and lifting ink station

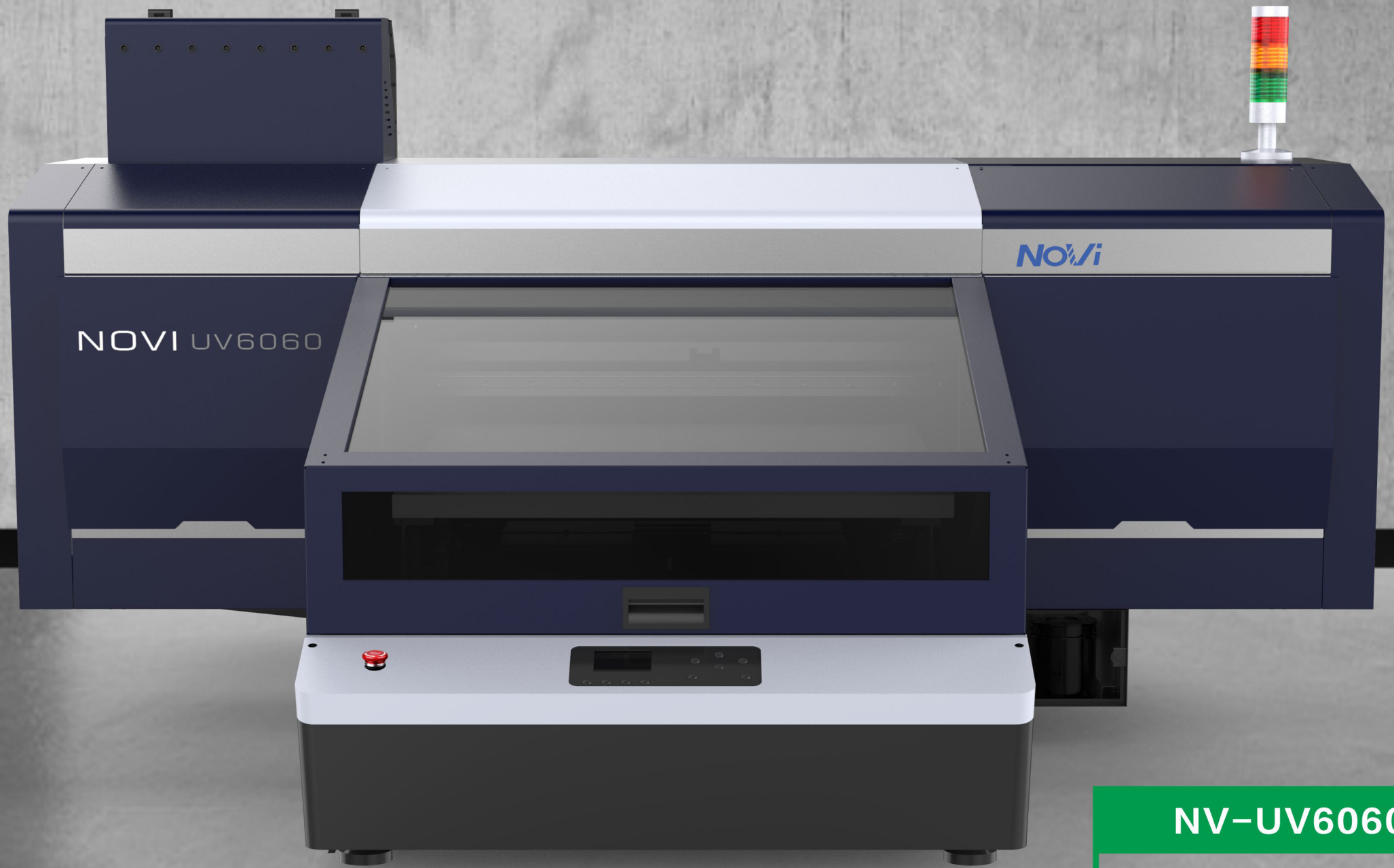

## NV-UV6060

- White, colors and varnish print at the same time
- High performance

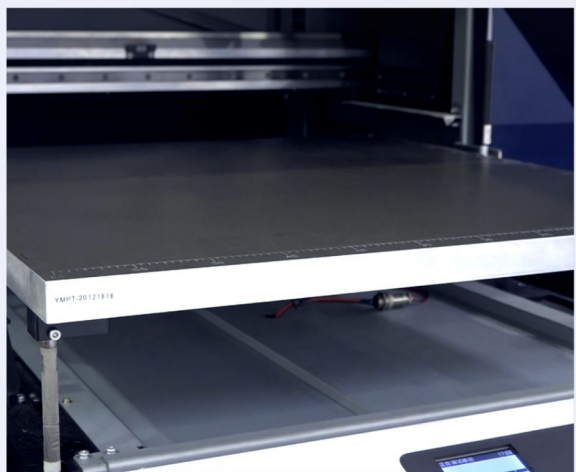
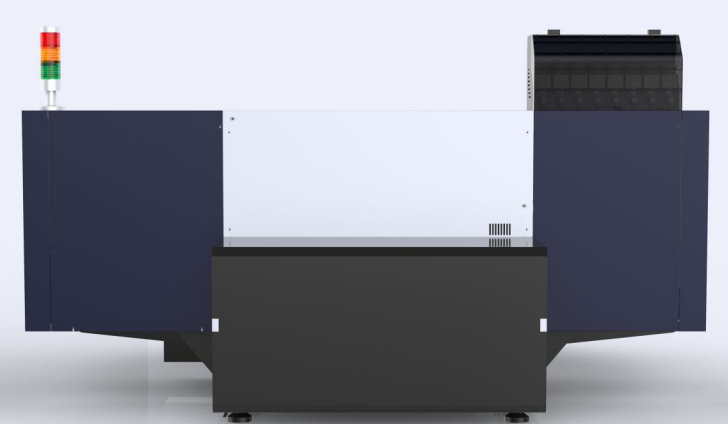
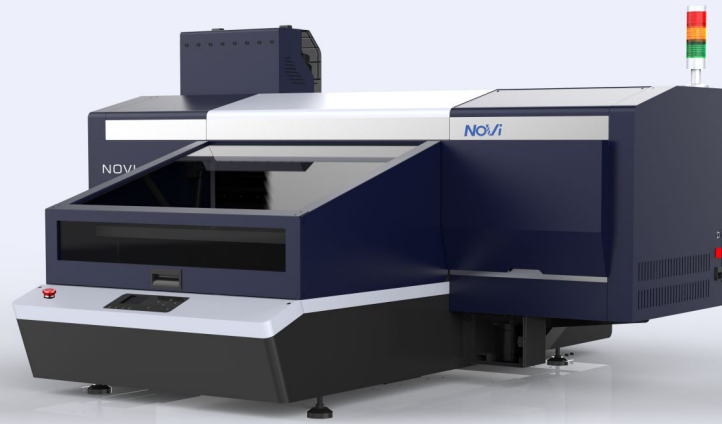
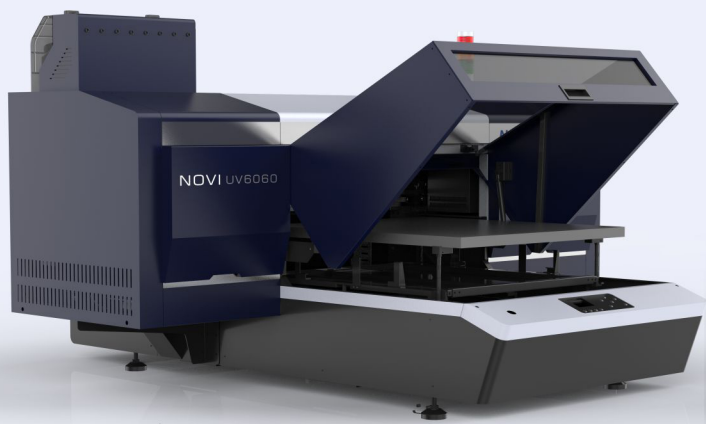

升降式标准刻度吸附平台  
升降式墨栈



电动圆柱体打印治具  
配备自动测高功能



负压式供墨系统

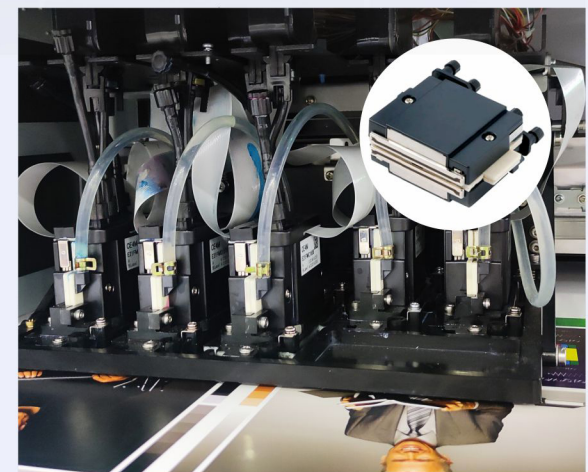

配置5个东芝CE4M工业打印头  
2400dpi高清打印，画质细腻

## 基础参数

Model: NV-UV6060  
Dimension: 1625mm\*1700mm\*960mm  
Print accuracy: 2400dpi  
Print mode: CMYK+W+V  
Print direction: single and double  
Weight: 166KG

Model of head: TOSHIBA Ce4  
Qty of head: 5  
Max printing scale: 600mm\*600mm  
Print thickness: 0-100mm  
Cylinder printing: support

Type of ink: UV-base  
Working environment: Temperature: 20°C-35°C  
Humidity: 35%-65%

